

DL/DLM3-60 Dimensions

Plugs

FRONT

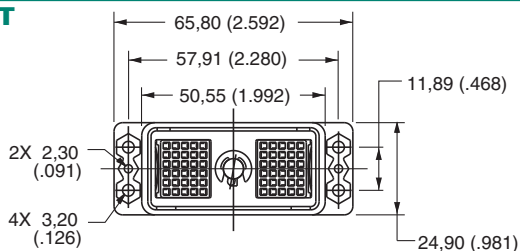

BACK

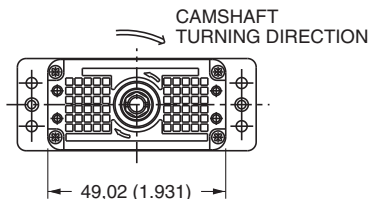

SIDE VIEWS

Contact Style	A
w/ .125	.125" (3.18)
4A, 4B	.605" (15.37)
6A, 6B	.280" (7.11)

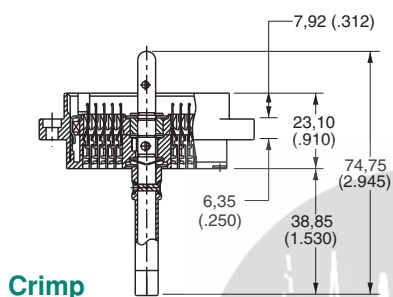

Crimp

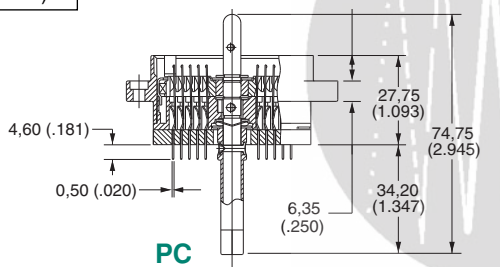

PC

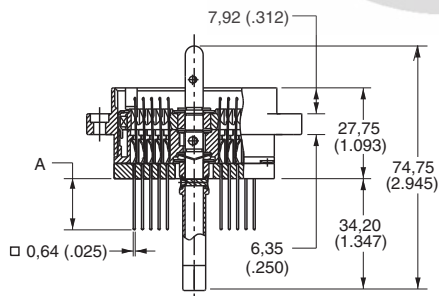

LAYOUT

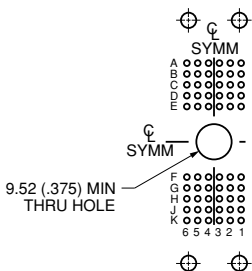

PANEL CUTOUT

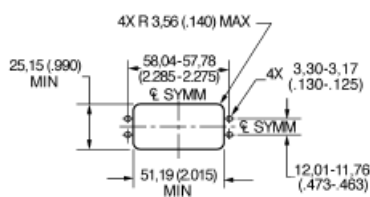

Receptacles

FRONT

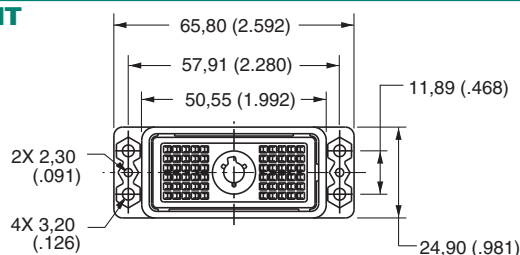

BACK

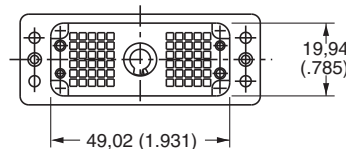

SIDE VIEWS

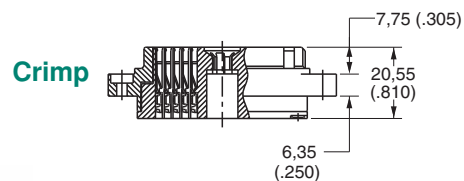

Crimp

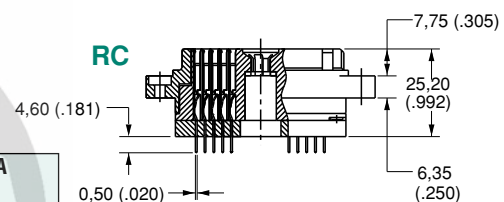

RC

Contact Style	A
w/ .125	.125" (3.18)
4A, 4B	.605" (15.37)
6A, 6B	.280" (7.11)

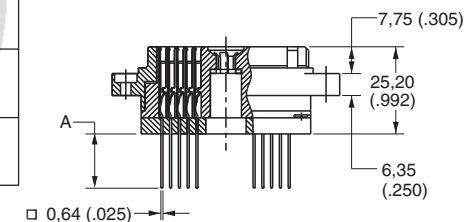

LAYOUT

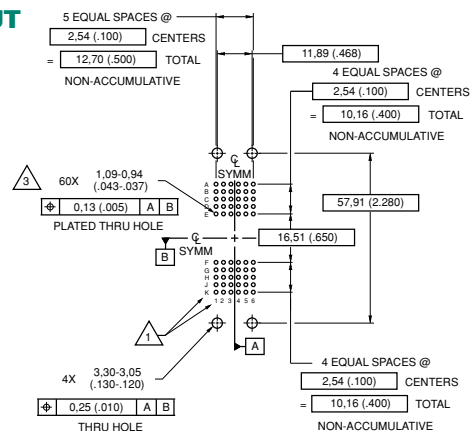

PANEL CUTOUT

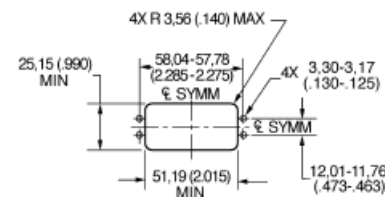

All dimensions are in mm (inches) unless otherwise indicated.

See back cover for contact details • www.PeiGenesis.com

Specifications subject to change.

DL/DLM2-96 Dimensions

Plugs

FRONT

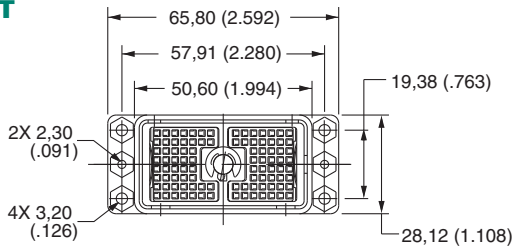

BACK

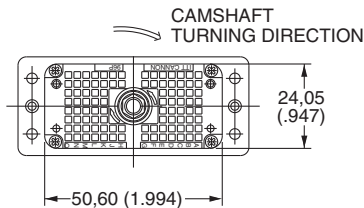

SIDE VIEWS

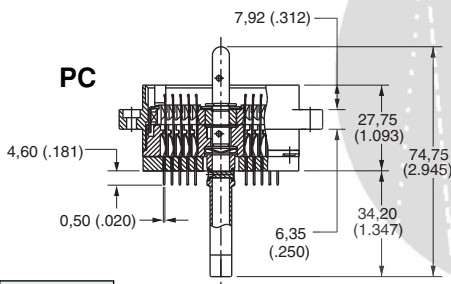
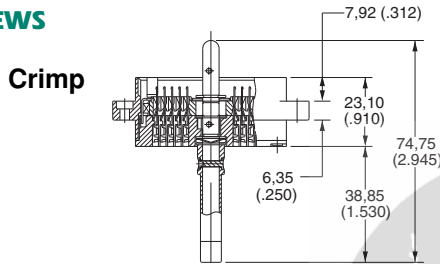

Contact Style	A
w/ .125	.125" (3.18)
4A, 4B	.605" (15.37)
6A, 6B	.280" (7.11)

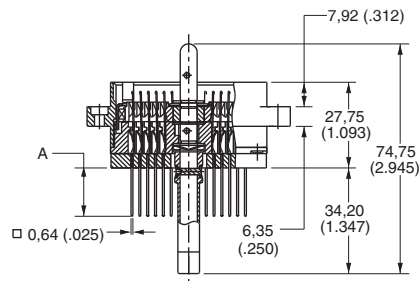

LAYOUT

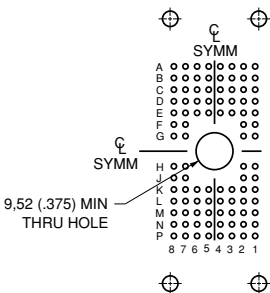

PANEL CUTOUT

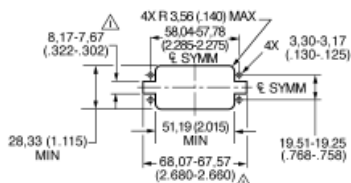

Receptacles

FRONT

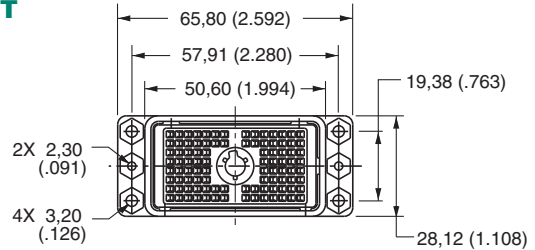

BACK

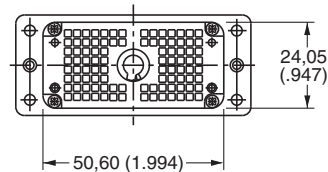

SIDE VIEWS

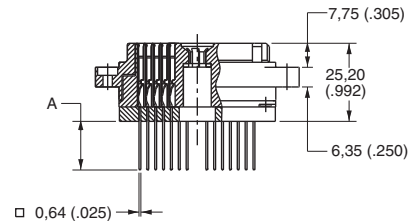
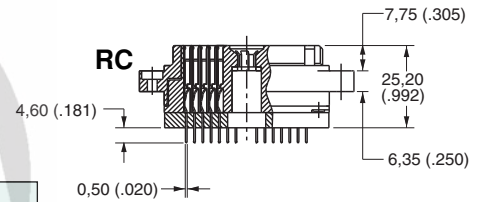
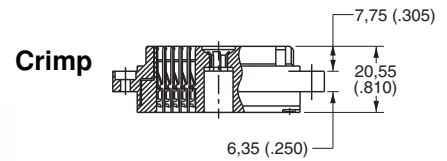

Contact Style	A
w/ .125	.125" (3.18)
4A, 4B	.605" (15.37)
6A, 6B	.280" (7.11)

LAYOUT

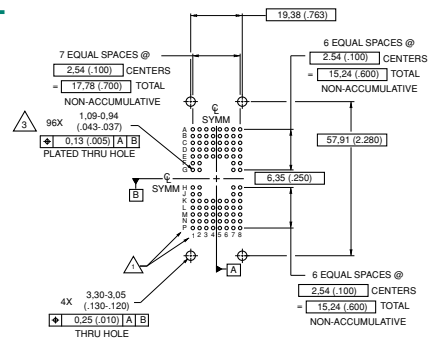

PANEL CUTOUT

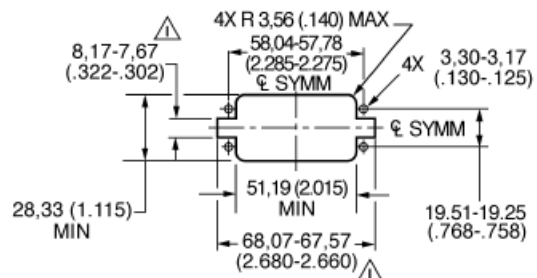

DLD2-96 Dimensions

Plugs

FRONT

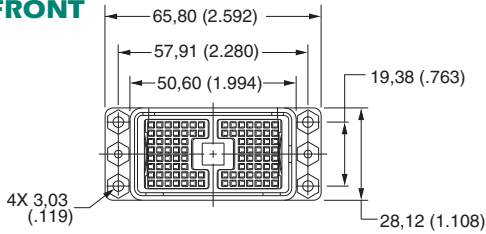

BACK

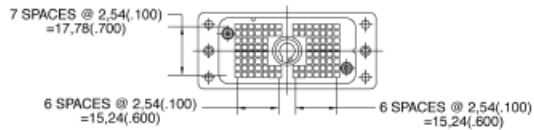

SIDE VIEWS

Crimp

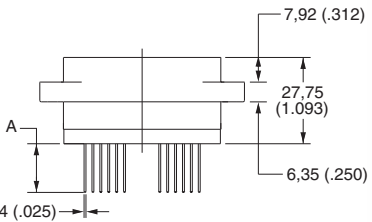
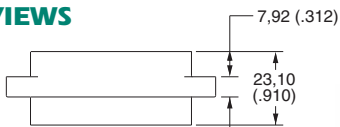

Contact Style	A
w/ .125	.125" (3.18)
4A, 4B	.605" (15.37)
6A, 6B	.280" (7.11)

LAYOUT

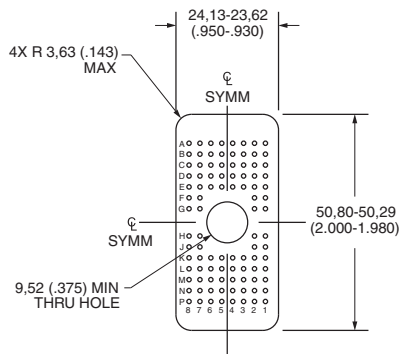

PANEL CUTOUT

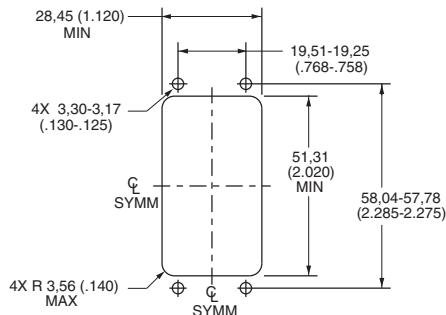

All dimensions are in mm (inches) unless otherwise indicated.

See back cover for contact details • www.Peigenesis.com

Receptacles

FRONT

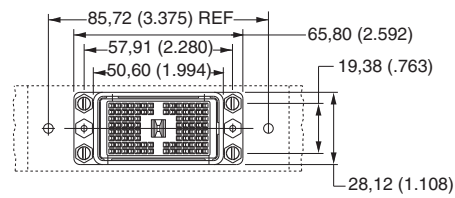

BACK

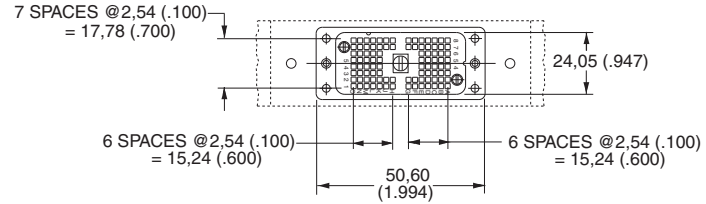

SIDE VIEWS

Crimp

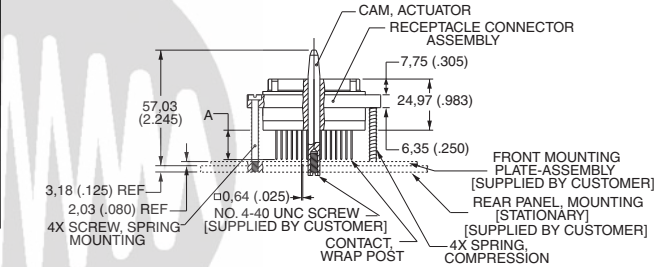
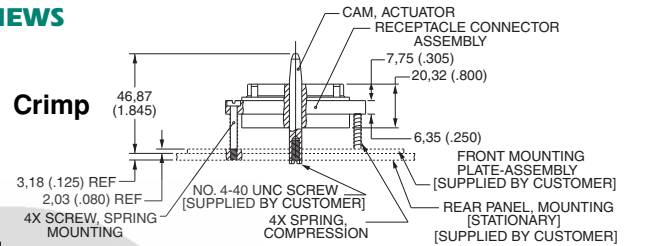

LAYOUT

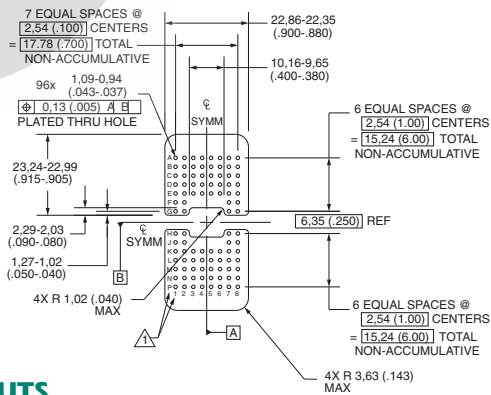

PANEL CUTOUTS

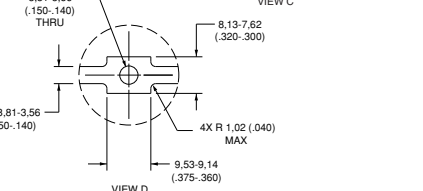
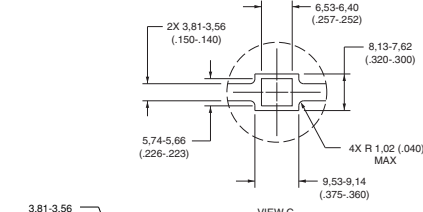
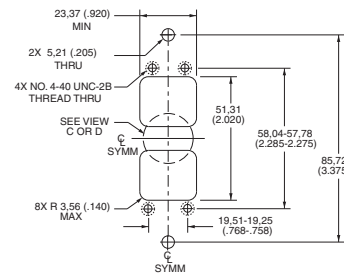

DLD/DLM

Specifications subject to change.

DL/DLM1-156 Dimensions

Plugs

FRONT

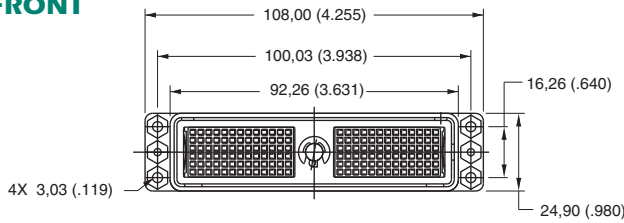

BACK

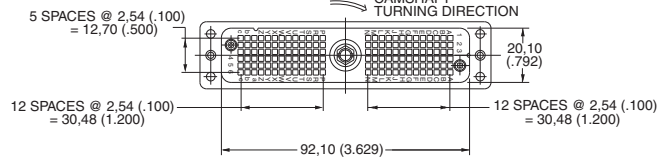

SIDE VIEWS

Crimp

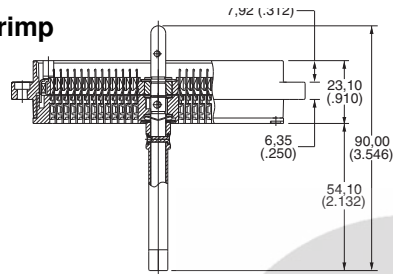

PC

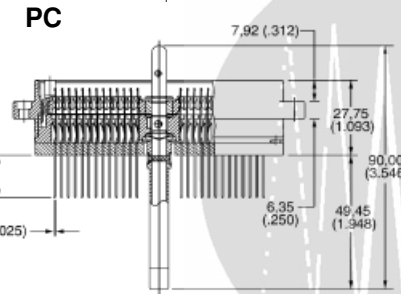

Contact Style	A
w/ .125	.125" (3.18)
4A, 4B	.605" (15.37)
6A, 6B	.280" (7.11)

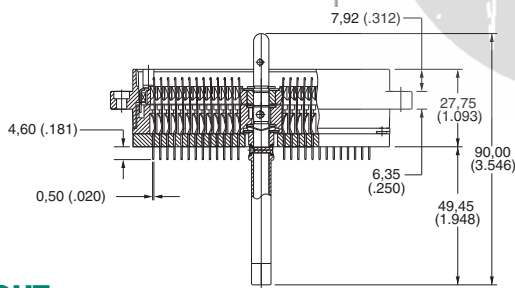

LAYOUT

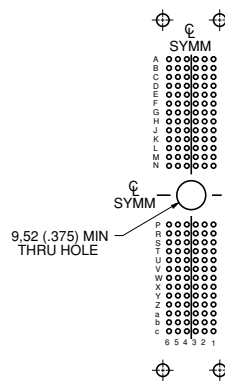

PANEL CUTOUT

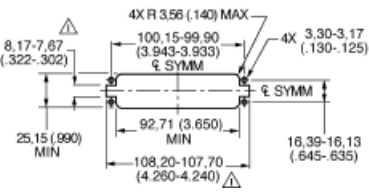

Receptacles

FRONT

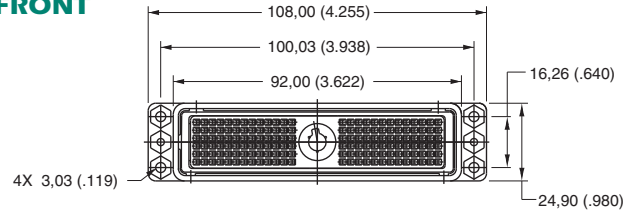

BACK

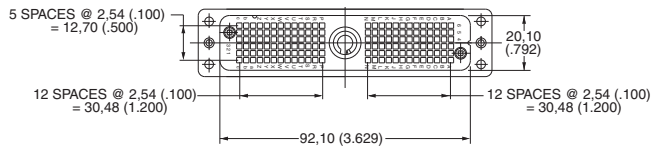

SIDE VIEWS

Crimp

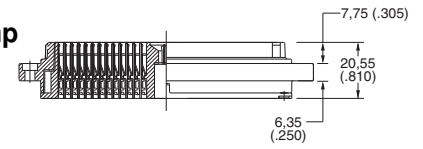

RC

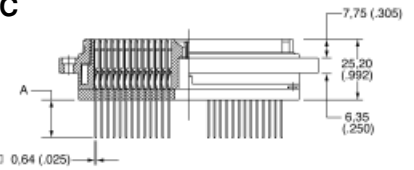

Contact Style	A
w/ .125	.125" (3.18)
4A, 4B	.605" (15.37)
6A, 6B	.280" (7.11)

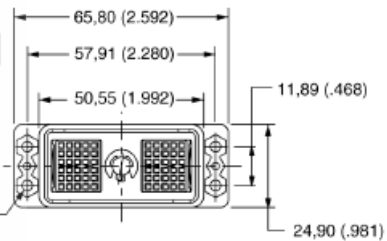

LAYOUT

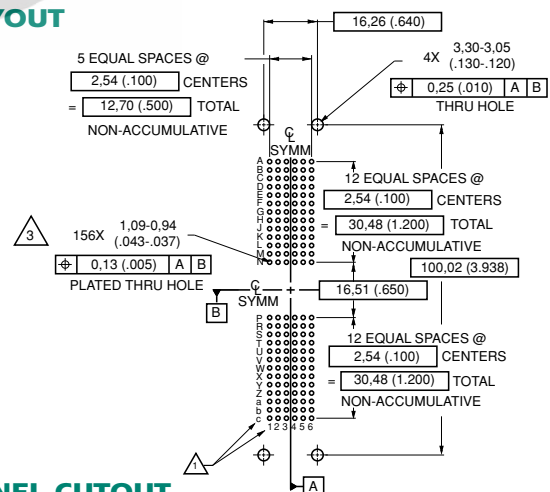

PANEL CUTOUT

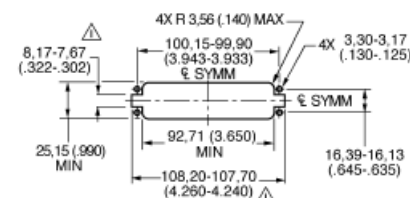

DL/DL/DLM

DLD1-156 Dimensions

Plugs

FRONT

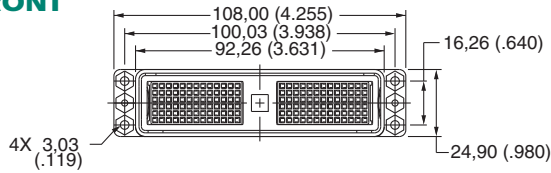

BACK

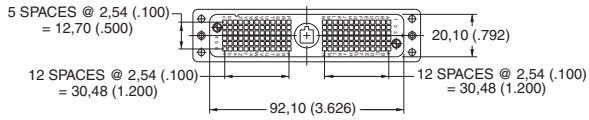

SIDE VIEWS

Crimp

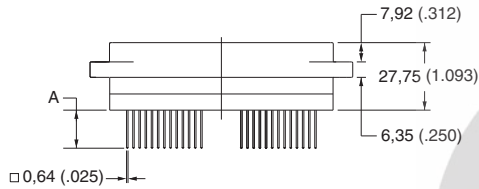
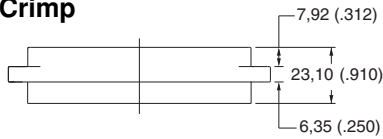

LAYOUT

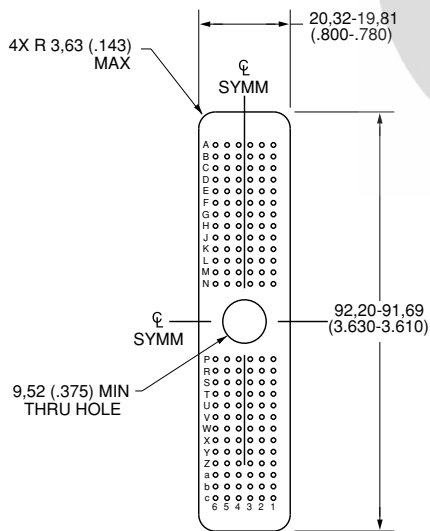

PANEL CUTOUT

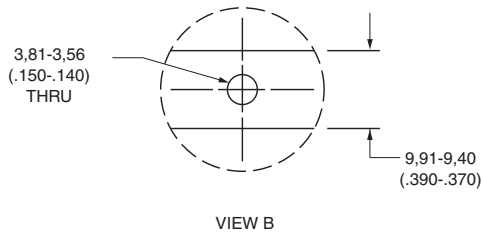

Receptacles

FRONT

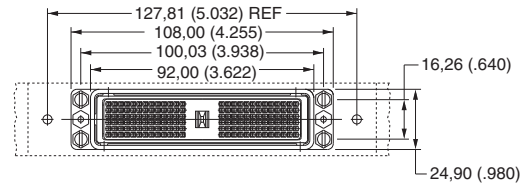

BACK

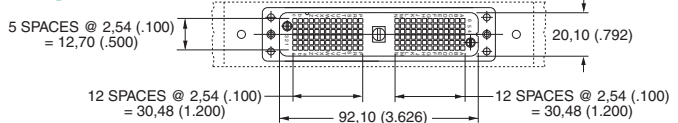

SIDE VIEWS

Crimp

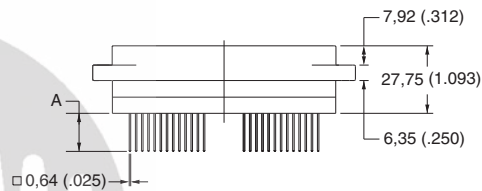
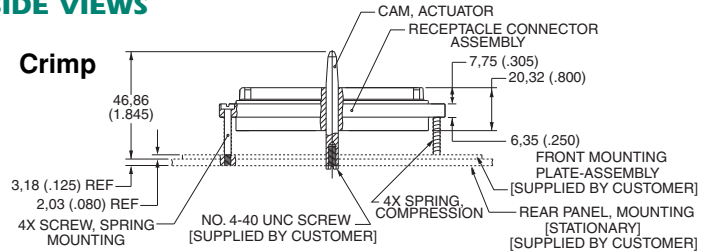

Contact Style	A
w/ .125	.125" (3.18)
4A, 4B	.605" (15.37)
6A, 6B	.280" (7.11)

LAYOUT

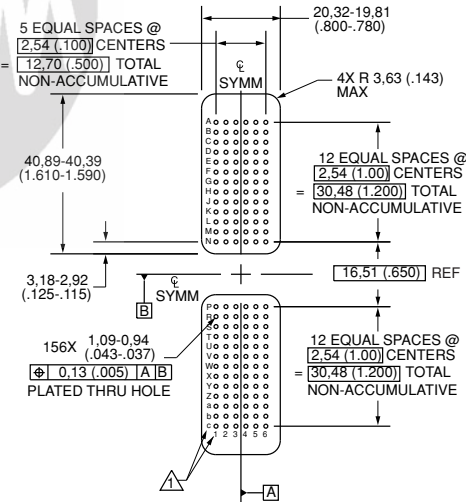

PANEL CUTOUTS

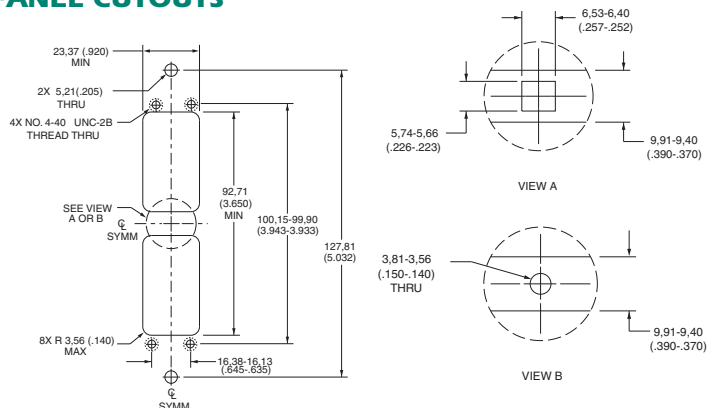

All dimensions are in mm (inches) unless otherwise indicated.

See back cover for contact details • www.PeiGenesis.com

Specifications subject to change.

DL/DLM5-260 Dimensions

Plugs

FRONT

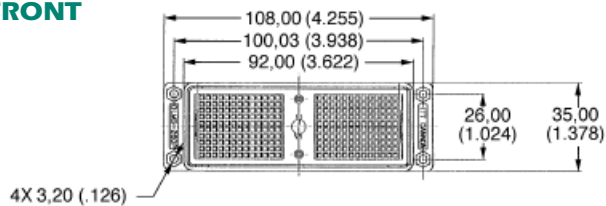

BACK

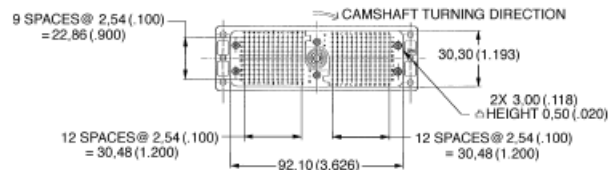

SIDE VIEWS

Crimp

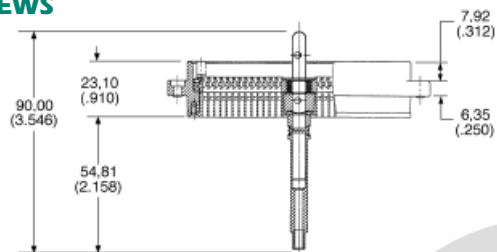

PC

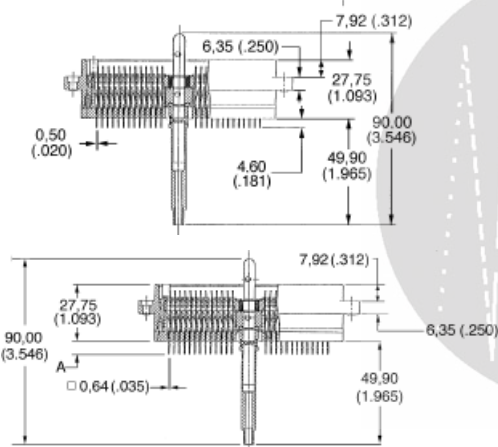

LAYOUT

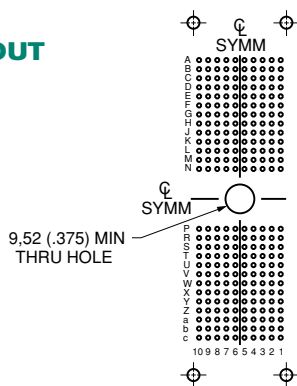

PANEL CUTOUT

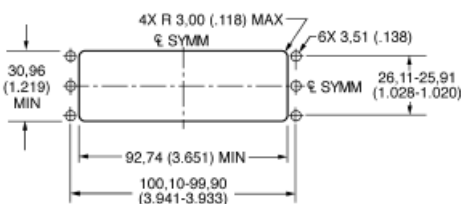

Receptacles

FRONT

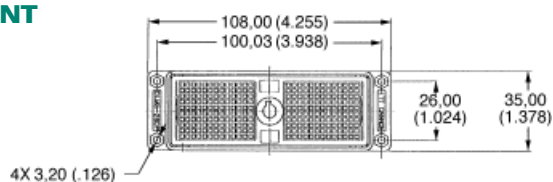

BACK

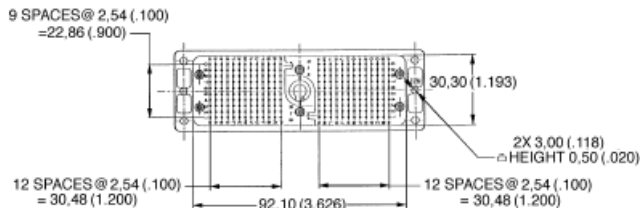

SIDE VIEWS

Crimp

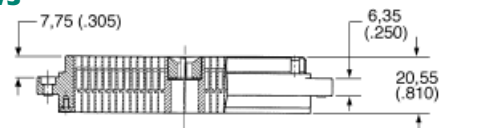

RC

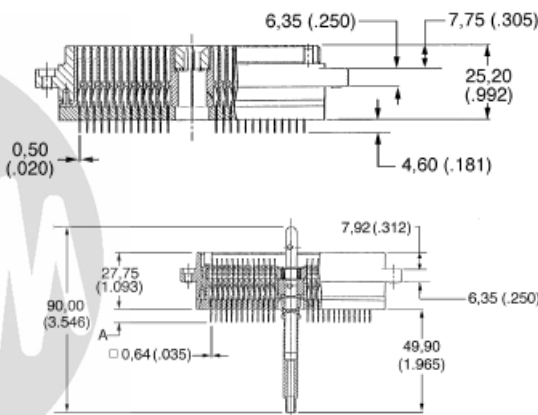

LAYOUT

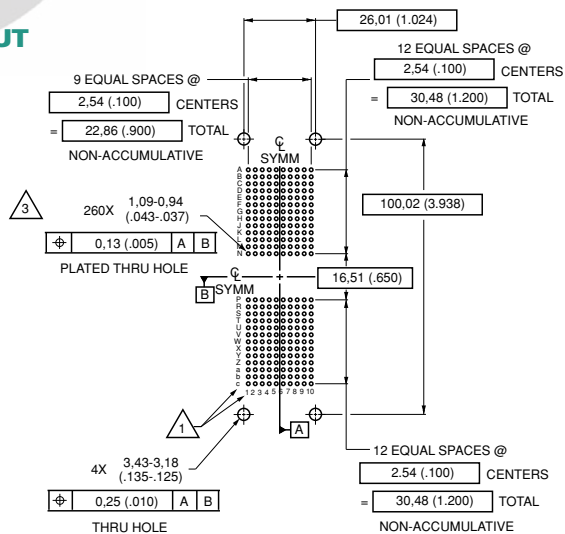

PANEL CUTOUT

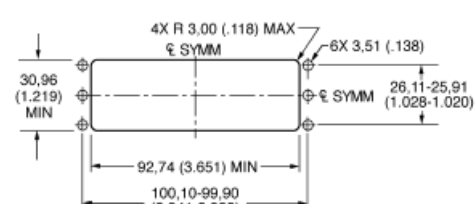

Contact Style	A
w/ .125	.125" (3.18)
4A, 4B	.605" (15.37)
6A, 6B	.280" (7.11)

DL/DLB/DLM

DLM6-360 Dimensions

Plugs

FRONT

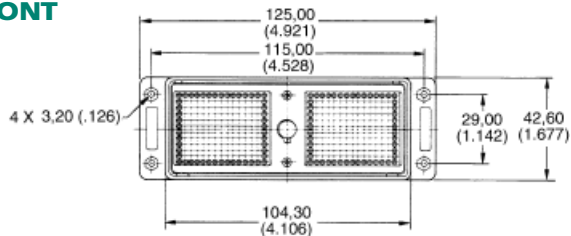

BACK

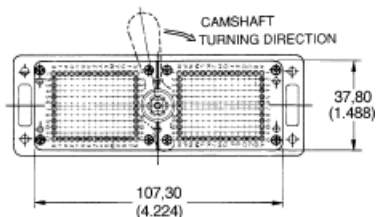

SIDE VIEWS

Crimp

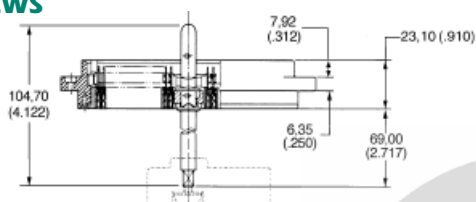

PC

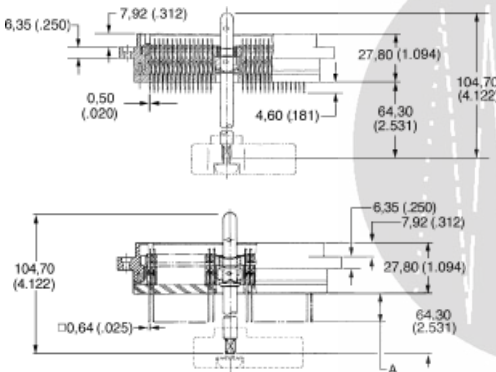

LAYOUT

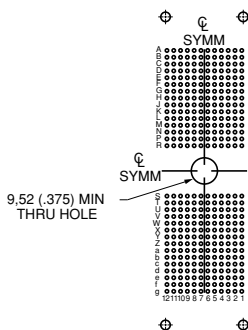

PANEL CUTOUT

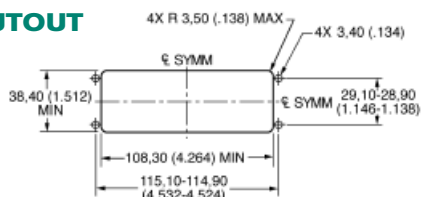

Receptacles

FRONT

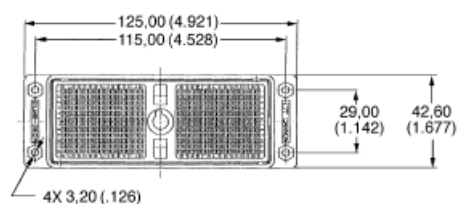

BACK

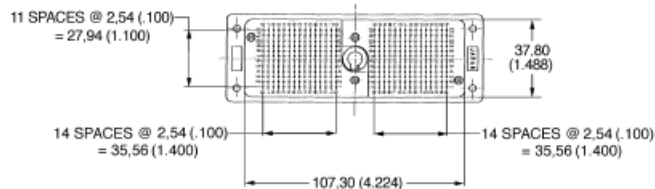

SIDE VIEWS

Crimp

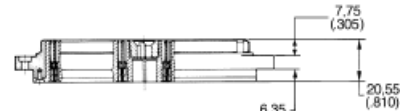

RC

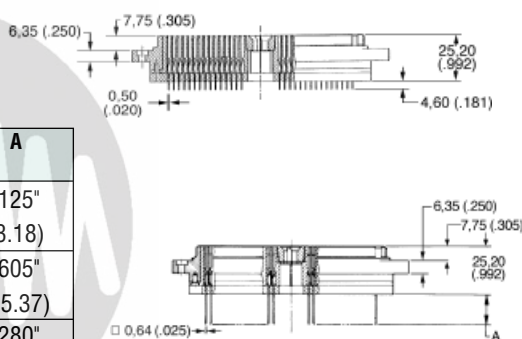

Contact Style	A
w/ .125	.125" (3.18)
4A, 4B	.605" (15.37)
6A, 6B	.280" (7.11)

LAYOUT

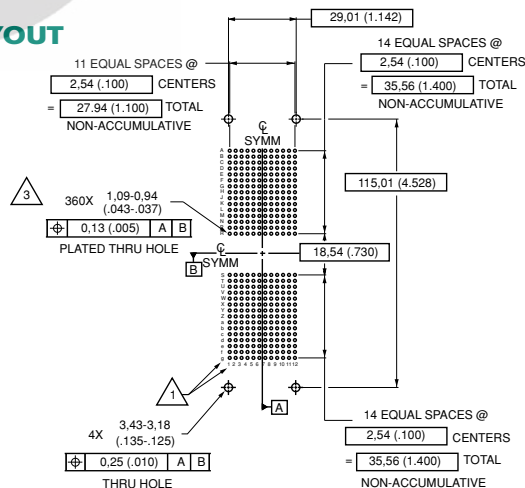

PANEL CUTOUT

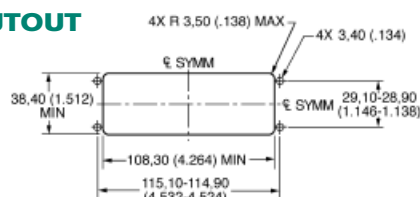

All dimensions are in mm (inches) unless otherwise indicated.

See back cover for contact details • www.PeiGenesis.com

Specifications subject to change.

DLD/DLM/DLM

DL4-624 Dimensions

Plugs

FRONT

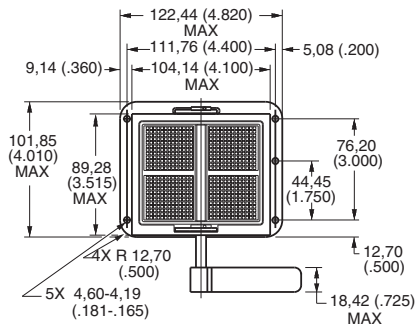

SIDE VIEWS

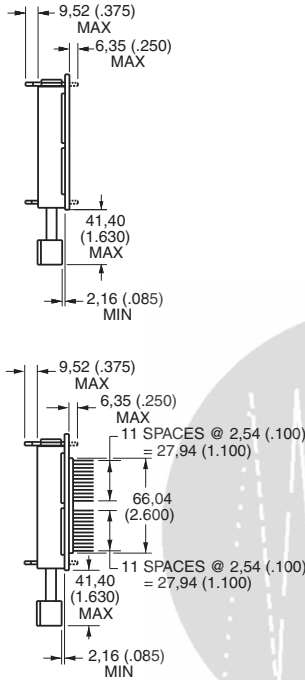

Crimp

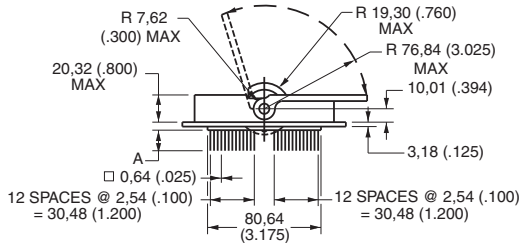
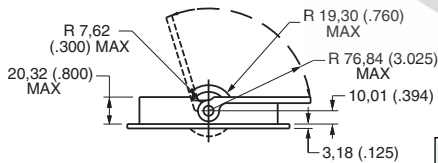

PANEL CUTOUT

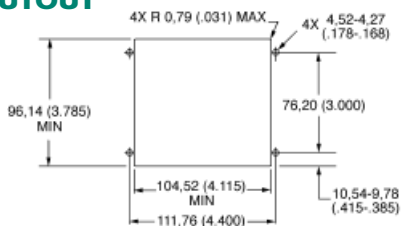

Receptacles

FRONT

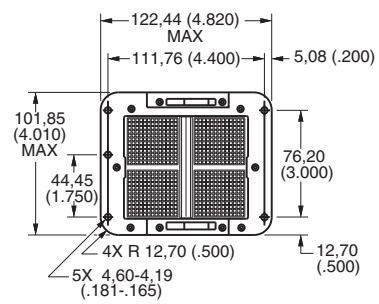

SIDE VIEWS

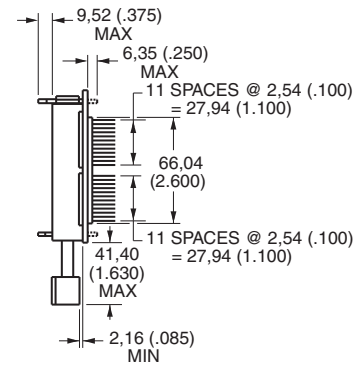
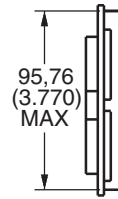

Crimp

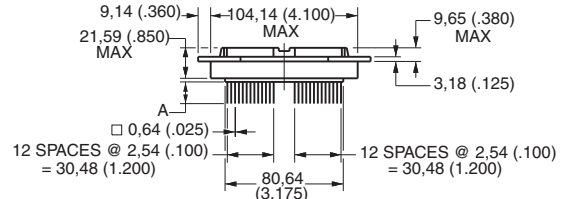
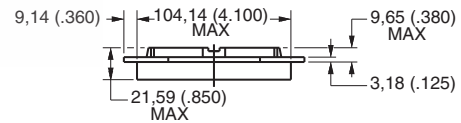

PANEL CUTOUT

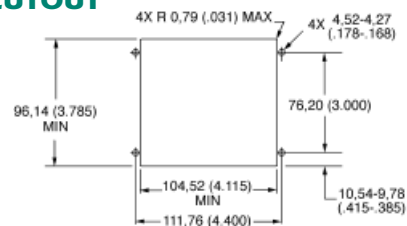

Contact Style	A
w/ .125	.125" (3.18)
4A, 4B	.605" (15.37)
6A, 6B	.280" (7.11)