

JBX2-04 - IP40 (4 x Ø 1.3 mm) - See waterproof IP68 version page 72

Dimensions (For mated connector lengths see page 75)

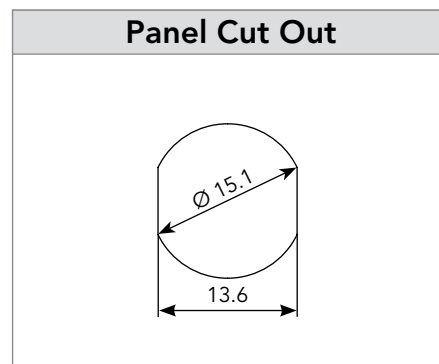
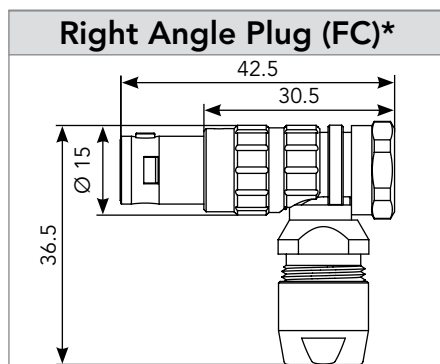
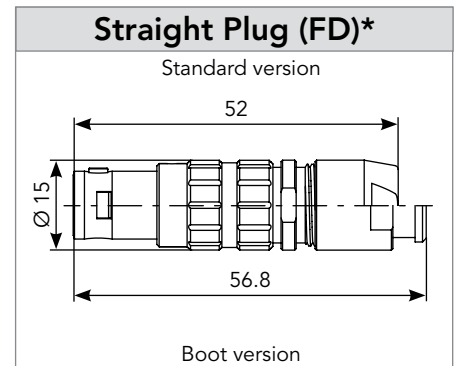
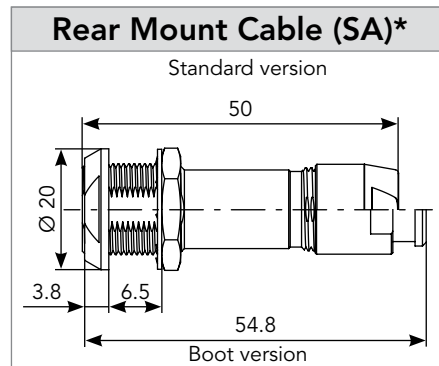
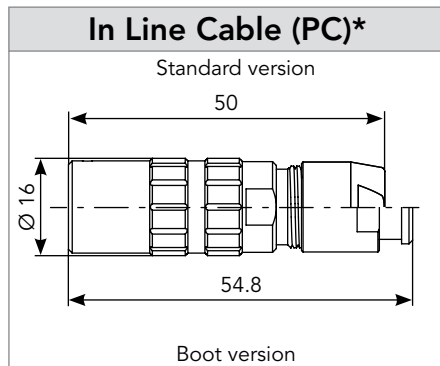
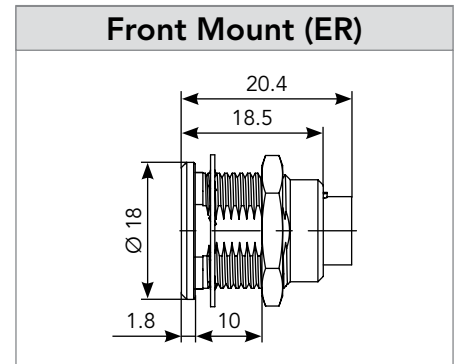
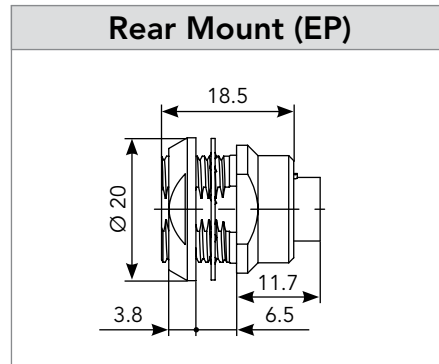
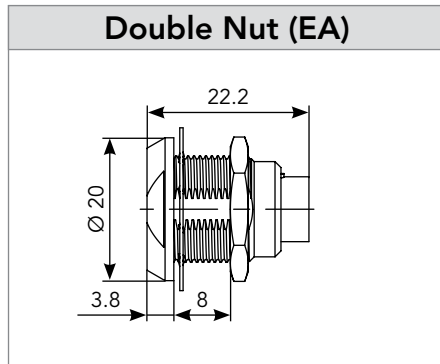

Note: all dimensions are in mm

JBX2-04 - IP68 (4 x Ø 1.3 mm) - See non sealed IP40 version page 70

Dimensions (For mated connector lengths see page 75)

